

Circular sensor connectors



M8 cables & connectors

The M8 Series provides a wide range of metric M8 connectors for small sensors and actuators. Available in a shielded form and rated to IP67, these connectors are ideally suited for industrial control networks where small sensors are required. Connectors are either factory TPU over-molded or panel receptacle supplied with a solder-cup for wire connecting or with PCB panel solder contacts. A field attachable/mountable connector is also available.

- Design as per IEC 61076-2-104
- Degree of protection IP67
- 3, 4, 5, 6, 8 poles are available
- 360° EMC shielding is available for molded cable type
- TPU over molded or PA+GF shell
- Anti-vibration locking screw design
- Cable length customized, PUR and PVC cable options

M8 Quick Search Table	Available Coding	A-coding		A-coding		B-coding		A-coding			
	Rated Current	3A		3A		3A		1.5A			
	Voltage	50V(A/C), 60V(D/C)		50V(A/C), 60V(D/C)		30V(A/C), 30V(D/C)		30V(A/C), 30V(D/C)			
	Wire Gauge / size	24AWG / 0.25mm ²		24AWG / 0.25mm ²		24AWG / 0.25mm ²		26AWG / 0.14mm ²			
Pin layout											
M8 cables & connectors		03 Pins		04 Pins		05 Pins		06 Pins		08 Pins	
Molded Cable											
	Male Molded Cable Straight	23	-	23	-	23	-	23	-	23	-
	Male Molded Cable Straight Shielded	26	-	26	-	26	-	26	-	26	-
	Male Molded Cable Straight Snap-in	28	-	28	-	-	-	-	-	-	-
	Female Molded Cable Straight	-	24	-	24	-	24	-	24	-	24
	Female Molded Cable Straight Plastic	-	25	-	25	-	25	-	25	-	25
	Female Molded Cable Straight Shielded	-	27	-	27	-	27	-	27	-	27
	Female Molded Cable Straight Snap-in	-	29	-	29	-	-	-	-	-	-
	Male Molded Cable Angled	30	-	30	-	30	-	30	-	30	-
	Male Molded Cable Angled Shielded	33	-	33	-	33	-	33	-	33	-
	Male Molded Cable Angled Snap-in	35	-	35	-	-	-	-	-	-	-
	Female Molded Cable Angled	-	31	-	31	-	31	-	31	-	31
	Female Molded Cable Angled Plastic	-	32	-	32	-	32	-	32	-	32
	Female Molded Cable Angled Shielded	-	34	-	34	-	34	-	34	-	34
	Female Molded Cable Angled Snap-in	-	36	-	36	-	-	-	-	-	-
	Female Molded Cable Angled with LED	-	37	-	37	-	-	-	-	-	-
Assembly Type											
	Male Field Wirable Assembly Straight Solder	38	-	38	-	38	-	38	-	38	-
	Female Field Wirable Assembly Straight Solder	-	39	-	39	-	39	-	39	-	39
	Male Field Wirable Assembly Straight Screw Joint Shielded	40	-	40	-	40	-	40	-	40	-
	Female Field Wirable Assembly Straight Screw Joint Shielded	-	41	-	41	-	41	-	41	-	41
Panel Mount Type											
	Male Panel Mount Solder Front fastened	42	-	42	-	42	-	42	-	42	-
	Male Panel Mount Solder Rear fastened	44	-	44	-	44	-	44	-	44	-
	Male Panel Mount Solder with LED	-	-	48	-	-	-	-	-	-	-
	Female Panel Mount Solder Front fastened	46	-	46	-	-	-	-	-	-	-
	Female Panel Mount Solder Rear fastened	47	-	47	-	-	-	-	-	-	-
	Male Panel Mount PCB Type Front fastened	49/51	-	49/51	-	49	-	-	-	-	-
	Male Panel Mount Angled PCB Type Front fastened Shielded	53	-	53	-	53	-	-	-	-	-
	Female Panel Mount PCB Type Front fastened	50	-	50	-	50	-	50	-	50	-
	Female Panel Mount Angled PCB Type Front fastened Shielded	54	-	54	-	54	-	-	-	-	-
	Male to Female Panel Mount	52	52	52	52	52	52	-	-	-	-
Splitter Connector											
	Y-Splitter Male-2 Female	55	55	55	55	55	55	-	-	-	-
	L-Adapter Male-Female	56	56	56	56	56	56	-	-	-	-
	Male Terminator Straight with LED	57	-	57	-	57	-	-	-	-	-
Protection Cap											
	Protection Cap for Male Connector										58-1
	Protection Cap for Male Molded Cable Connector										59-1
	Protection Cap for Male Panel-mount Connector										60-1
	Protection Cap for Female Connector										58-2
	Protection Cap for Female Molded Cable Connector										59-2
	Protection Cap for Female Panel-mount Connector										60-2

How to Order Part Number

M8 Series with cable molded

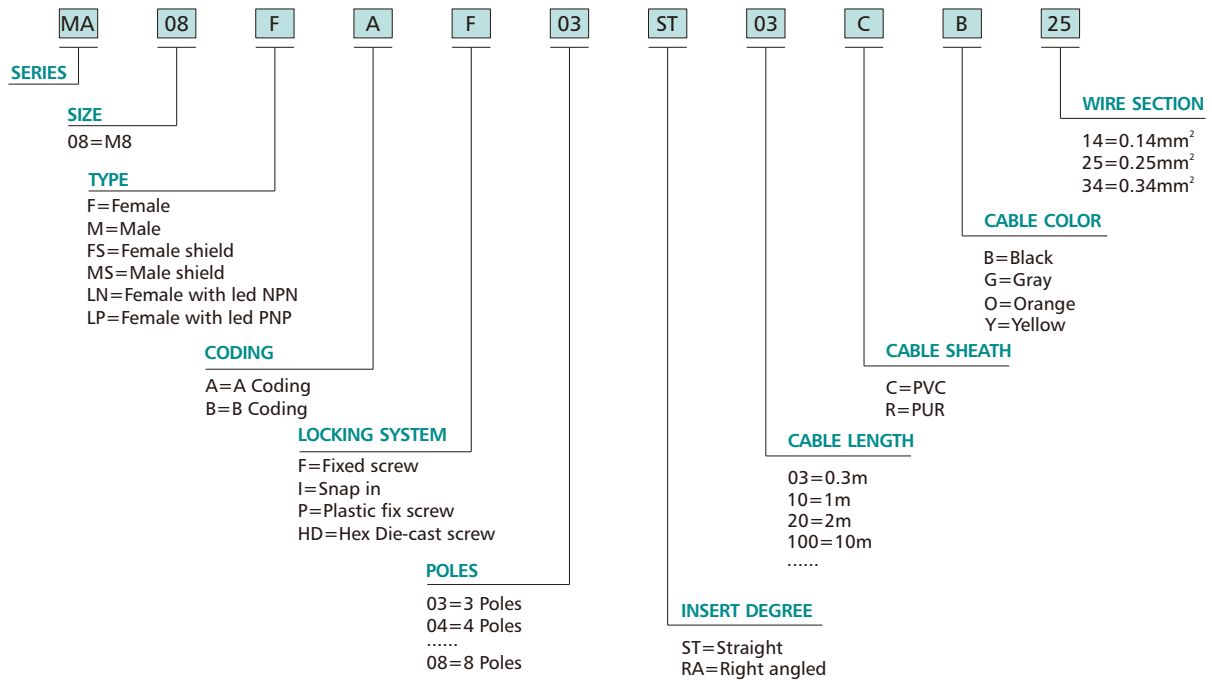

M8 Series Assembly / Panel-mount type

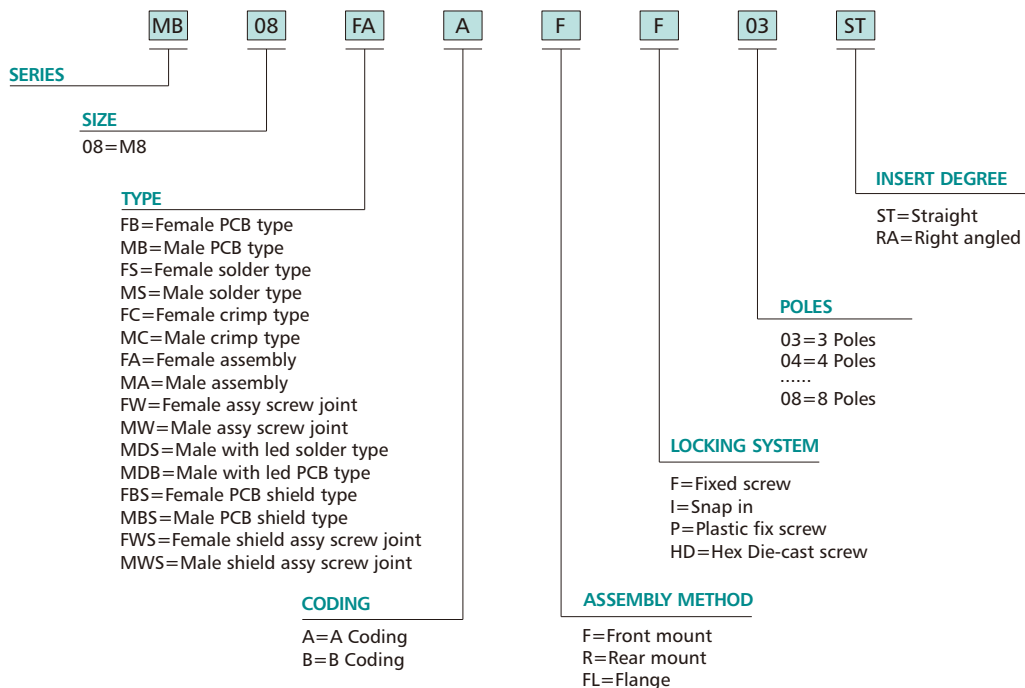

M8 Male Molded Cable, Straight

- Connector series: M8
- Gender: Male
- Coding: A,B
- Locking type: Fix screw
- Mounting type: Straight
- Part No.: MA08M*HD**STXXXXXX

* refers to coding type
 ** refers to pins number
 X refers to cable specification

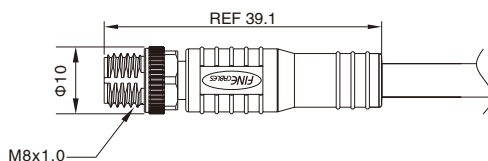

General information

Standard:	IEC 61076-2-104
Ambient temperature:	-40°C ~ +80°C(fixed installation) -20°C ~ +80°C(flexible installation)
Connector insert:	TPU
Connector contacts:	Brass with gold plated
Connector overmold:	TPU
Connector nut/screw:	Zinc alloy with nickel plated

Insulation resistance:	≥ 100MΩ
Contact resistance:	≤ 5mΩ
Shielding:	Unavailable
IP rating:	IP67 in locked condition
Mating endurance:	>500 cycles

Electrical data & Mechanical data

Contacts	Rated current	Voltage		Wire gauge / size		Cable jacket	Part No.
		A/C	D/C	AWG	mm ²		
03 pins (A-coding)	3A	50V	60V	24AWG	0.25	PVC	MA08MAHD03STXXCB25
						PUR	MA08MAHD03STXXRB25
04 pins (A-coding)	3A	50V	60V	24AWG	0.25	PVC	MA08MAHD04STXXCB25
						PUR	MA08MAHD04STXXRB25
05 pins (B-coding)	3A	30V	30V	24AWG	0.25	PVC	MA08MBHD05STXXCB25
						PUR	MA08MBHD05STXXRB25
06 pins (A-coding)	1.5A	30V	30V	26AWG	0.14	PVC	MA08MAHD06STXXCB14
						PUR	MA08MAHD06STXXRB14
08 pins (A-coding)	1.5A	30V	30V	26AWG	0.14	PVC	MA08MAHD08STXXCB14
						PUR	MA08MAHD08STXXRB14

Note: X refers to cable length

Remarks

- Please refer to Page 578 for the Conversion between American Wire Gauge AWG and Wire Cross-section mm².
- Please refer to Page 22 for products' part number encoding rule.

M8 Female Molded Cable, Straight

- Connector series: M8
- Gender: Female
- Coding: A,B
- Locking type: Fix screw
- Mounting type: Straight
- Part No.: MA08F*HD**STXXXXXX

* refers to coding type
 ** refers to pins number
 X refers to cable specification

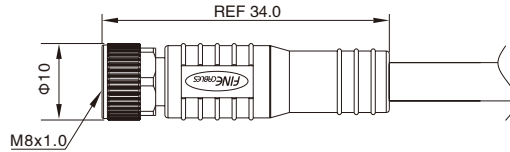

General information

Standard:	IEC 61076-2-104
Ambient temperature:	-40°C ~ +80°C (fixed installation) -20°C ~ +80°C (flexible installation)
Connector insert:	TPU
Connector contacts:	Brass with gold plated
Connector overmold:	TPU
Connector nut/screw:	Zinc alloy with nickel plated
Seal / O-ring:	FKM

Insulation resistance:	≥ 100MΩ
Contact resistance:	≤ 5mΩ
Shielding:	Unavailable
IP rating:	IP67 in locked condition
Mating endurance:	>500 cycles

Electrical data & Mechanical data

Contacts	Rated current	Voltage		Wire gauge / size		Cable jacket	Part No.
		A/C	D/C	AWG	mm ²		
03 pins (A-coding)	3A	50V	60V	24AWG	0.25	PVC	MA08FAHD03STXXCB25
						PUR	MA08FAHD03STXXRB25
04 pins (A-coding)	3A	50V	60V	24AWG	0.25	PVC	MA08FAHD04STXXCB25
						PUR	MA08FAHD04STXXRB25
05 pins (B-coding)	3A	30V	30V	24AWG	0.25	PVC	MA08FBHD05STXXCB25
						PUR	MA08FBHD05STXXRB25
06 pins (A-coding)	1.5A	30V	30V	26AWG	0.14	PVC	MA08FAHD06STXXCB14
						PUR	MA08FAHD06STXXRB14
08 pins (A-coding)	1.5A	30V	30V	26AWG	0.14	PVC	MA08FAHD08STXXCB14
						PUR	MA08FAHD08STXXRB14

Note: X refers to cable length

Remarks

- Please refer to Page 578 for the Conversion between American Wire Gauge AWG and Wire Cross-section mm².
- Please refer to Page 22 for products' part number encoding rule.

M8 Female Molded Cable, Straight, Plastic Nut

- Connector series: M8
- Gender: Female
- Coding: A,B
- Locking type: Plastic fix screw
- Mounting type: Straight
- Part No.: MA08F*P**STXXXXXX

* refers to coding type
 ** refers to pins number
 X refers to cable specification

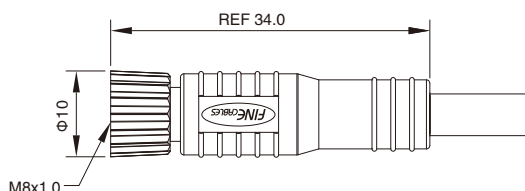

General information

Standard:	IEC 61076-2-104
Ambient temperature:	-40°C ~ +80°C(fixed installation) -20°C ~ +80°C(flexible installation)
Connector insert:	TPU
Connector contacts:	Brass with gold plated
Connector overmold:	TPU
Connector nut/screw:	PA+GF
Seal / O-ring:	FKM

Insulation resistance:	≥ 100MΩ
Contact resistance:	≤ 5mΩ
Shielding:	Unavailable
IP rating:	IP67 in locked condition
Mating endurance:	>500 cycles

Electrical data & Mechanical data

Contacts	Rated current	Voltage		Wire gauge / size		Cable jacket	Part No.
		A/C	D/C	AWG	mm ²		
03 pins (A-coding)	3A	50V	60V	24AWG	0.25	PVC	MA08FAP03STXXCB25
						PUR	MA08FAP03STXXRB25
04 pins (A-coding)	3A	50V	60V	24AWG	0.25	PVC	MA08FAP04STXXCB25
						PUR	MA08FAP04STXXRB25
05 pins (B-coding)	3A	30V	30V	24AWG	0.25	PVC	MA08FBP05STXXCB25
						PUR	MA08FBP05STXXRB25
06 pins (A-coding)	1.5A	30V	30V	26AWG	0.14	PVC	MA08FAP06STXXCB14
						PUR	MA08FAP06STXXRB14
08 pins (A-coding)	1.5A	30V	30V	26AWG	0.14	PVC	MA08FAP08STXXCB14
						PUR	MA08FAP08STXXRB14

Note: X refers to cable length

Remarks

- Please refer to Page 578 for the Conversion between American Wire Gauge AWG and Wire Cross-section mm².
- Please refer to Page 22 for products' part number encoding rule.

M8 Male Molded Cable, Straight, Shielded

- Connector series: M8
- Gender: Male
- Coding: A,B
- Locking type: Fix screw
- Mounting type: Straight
- Part No.: MA08MS*F**STXXXXXX

* refers to coding type
 ** refers to pins number
 X refers to cable specification

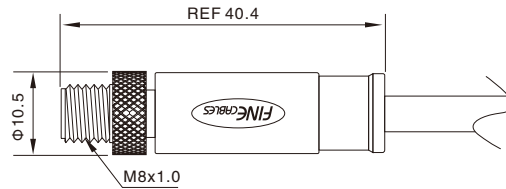

General information

Standard:	IEC 61076-2-104
Ambient temperature:	-40°C ~ +80°C (fixed installation) -20°C ~ +80°C (flexible installation)
Connector insert:	TPU
Connector contacts:	Brass with gold plated
Connector overmold:	TPU
Connector nut/screw:	Brass with nickel plated

Insulation resistance:	≥ 100MΩ
Contact resistance:	≤ 5mΩ
Shielding:	Available
IP rating:	IP67 in locked condition
Mating endurance:	>500 cycles

Electrical data & Mechanical data

Contacts	Rated current	Voltage		Wire gauge / size		Cable jacket	Part No.
		A/C	D/C	AWG	mm ²		
03 pins (A-coding)	3A	50V	60V	24AWG	0.25	PVC	MA08MSAF03STXXCB25
						PUR	MA08MSAF03STXXRB25
04 pins (A-coding)	3A	50V	60V	24AWG	0.25	PVC	MA08MSAF04STXXCB25
						PUR	MA08MSAF04STXXRB25
05 pins (B-coding)	3A	30V	30V	24AWG	0.25	PVC	MA08MSBF05STXXCB25
						PUR	MA08MSBF05STXXRB25
06 pins (A-coding)	1.5A	30V	30V	26AWG	0.14	PVC	MA08MSAF06STXXCB14
						PUR	MA08MSAF06STXXRB14
08 pins (A-coding)	1.5A	30V	30V	26AWG	0.14	PVC	MA08MSAF08STXXCB14
						PUR	MA08MSAF08STXXRB14

Note: X refers to cable length

Remarks

- Please refer to Page 578 for the Conversion between American Wire Gauge AWG and Wire Cross-section mm².
- Please refer to Page 22 for products' part number encoding rule.

M8 Female Molded Cable, Straight, Shielded

- Connector series: M8
- Gender: Female
- Coding: A,B
- Locking type: Fix screw
- Mounting type: Straight
- Part No.: MA08FS*F**STXXXXXX

* refers to coding type
 ** refers to pins number
 X refers to cable specification

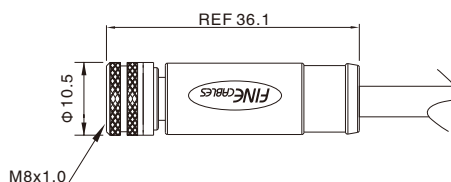

General information

Standard:	IEC 61076-2-104
Ambient temperature:	-40°C ~ +80°C(fixed installation) -20°C ~ +80°C(flexible installation)
Connector insert:	TPU; PA
Connector contacts:	Brass with gold plated
Connector overmold:	TPU
Connector nut/screw:	Brass with nickel plated
Seal / O-ring:	FKM

Insulation resistance:	≥ 100MΩ
Contact resistance:	≤ 5mΩ
Shielding:	Available
IP rating:	IP67 in locked condition
Mating endurance:	>500 cycles

Electrical data & Mechanical data

Contacts	Rated current	Voltage		Wire gauge / size		Cable jacket	Part No.
		A/C	D/C	AWG	mm ²		
03 pins (A-coding)	3A	50V	60V	24AWG	0.25	PVC	MA08FSAF03STXXCB25
						PUR	MA08FSAF03STXXRB25
04 pins (A-coding)	3A	50V	60V	24AWG	0.25	PVC	MA08FSAF04STXXCB25
						PUR	MA08FSAF04STXXRB25
05 pins (B-coding)	3A	30V	30V	24AWG	0.25	PVC	MA08FSBF05STXXCB25
						PUR	MA08FSBF05STXXRB25
06 pins (A-coding)	1.5A	30V	30V	26AWG	0.14	PVC	MA08FSAF06STXXCB14
						PUR	MA08FSAF06STXXRB14
08 pins (A-coding)	1.5A	30V	30V	26AWG	0.14	PVC	MA08FSAF08STXXCB14
						PUR	MA08FSAF08STXXRB14

Note: X refers to cable length

Remarks

- Please refer to Page 578 for the Conversion between American Wire Gauge AWG and Wire Cross-section mm².
- Please refer to Page 22 for products' part number encoding rule.

M8 Male Molded Cable, Straight, Snap-in Type

- Connector series: M8
- Gender: Male
- Coding: A
- Locking type: Snap-in
- Mounting type: Straight
- Part No.: MA08MAI**STXXXXXX

** refers to pins number
X refers to cable specification

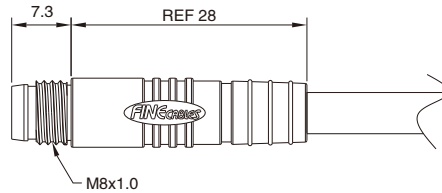

General information

Standard:	IEC 61076-2-104
Ambient temperature:	-40°C ~ +80°C (fixed installation) -20°C ~ +80°C (flexible installation)
Connector insert:	TPU
Connector contacts:	Brass with gold plated
Connector overmold:	TPU

Insulation resistance:	≥ 100MΩ
Contact resistance:	≤ 5mΩ
Shielding:	Unavailable
IP rating:	IP65 in locked condition
Mating endurance:	>500 cycles

Electrical data & Mechanical data

Contacts	Rated current	Voltage		Wire gauge / size		Cable jacket	Part No.
		A/C	D/C	AWG	mm ²		
03 pins (A-coding)	3A	50V	60V	24AWG	0.25	PVC	MA08MAI03STXXCB25
						PUR	MA08MAI03STXXRB25
04 pins (A-coding)	3A	50V	60V	24AWG	0.25	PVC	MA08MAI04STXXCB25
						PUR	MA08MAI04STXXRB25

Note: X refers to cable length

Remarks

- Please refer to Page 578 for the Conversion between American Wire Gauge AWG and Wire Cross-section mm².
- Please refer to Page 22 for products' part number encoding rule.

M8 Female Molded Cable, Straight, Snap-in Type

- Connector series: M8
- Gender: Female
- Coding: A
- Locking type: Snap-in
- Mounting type: Straight
- Part No.: MA08FAI**STXXXXXX

** refers to pins number
X refers to cable specification

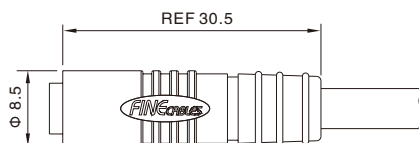

General information

Standard:	IEC 61076-2-104
Ambient temperature:	-40°C ~ +80°C(fixed installation) -20°C ~ +80°C(flexible installation)
Connector insert:	TPU; PA
Connector contacts:	Brass with gold plated
Connector overmold:	TPU

Insulation resistance:	≥ 100MΩ
Contact resistance:	≤ 5mΩ
Shielding:	Unavailable
IP rating:	IP65 in locked condition
Mating endurance:	>500 cycles

Electrical data & Mechanical data

Contacts	Rated current	Voltage		Wire gauge / size		Cable jacket	Part No.
		A/C	D/C	AWG	mm ²		
03 pins (A-coding)	3A	50V	60V	24AWG	0.25	PVC	MA08FAI03STXXCB25
						PUR	MA08FAI03STXXRB25
04 pins (A-coding)	3A	50V	60V	24AWG	0.25	PVC	MA08FAI04STXXCB25
						PUR	MA08FAI04STXXRB25

Note: X refers to cable length

Remarks

- Please refer to Page 578 for the Conversion between American Wire Gauge AWG and Wire Cross-section mm².
- Please refer to Page 22 for products' part number encoding rule.

M8 Male Molded Cable, Angled

- Connector series: M8
- Gender: Male
- Coding: A,B
- Locking type: Fix screw
- Mounting type: Right angled
- Part No.: MA08M*HD**RAXXXXXX

* refers to coding type
 ** refers to pins number
 X refers to cable specification

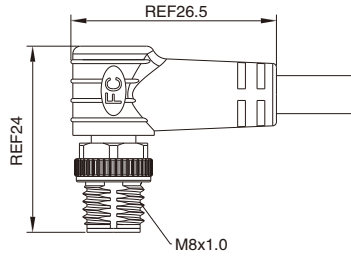

General information

Standard:	IEC 61076-2-104
Ambient temperature:	-40°C ~ +80°C(fixed installation) -20°C ~ +80°C(flexible installation)
Connector insert:	TPU
Connector contacts:	Brass with gold plated
Connector overmold:	TPU
Connector nut/screw:	Zinc alloy with nickel plated

Insulation resistance:	≥ 100MΩ
Contact resistance:	≤ 5mΩ
Shielding:	Unavailable
IP rating:	IP67 in locked condition
Mating endurance:	>500 cycles

Electrical data & Mechanical data

Contacts	Rated current	Voltage		Wire gauge / size		Cable jacket	Part No.
		A/C	D/C	AWG	mm ²		
03 pins (A-coding)	3A	50V	60V	24AWG	0.25	PVC	MA08MAHD03RAXXCB25
						PUR	MA08MAHD03RAXXRB25
04 pins (A-coding)	3A	50V	60V	24AWG	0.25	PVC	MA08MAHD04RAXXCB25
						PUR	MA08MAHD04RAXXRB25
05 pins (B-coding)	3A	30V	30V	24AWG	0.25	PVC	MA08MBHD05RAXXCB25
						PUR	MA08MBHD05RAXXRB25
06 pins (A-coding)	1.5A	30V	30V	26AWG	0.14	PVC	MA08MAHD06RAXXCB14
						PUR	MA08MAHD06RAXXRB14
08 pins (A-coding)	1.5A	30V	30V	26AWG	0.14	PVC	MA08MAHD08RAXXCB14
						PUR	MA08MAHD08RAXXRB14

*06 Pin,08 Pin with different overmold from above other pins

Note: X refers to cable length

Remarks

- Please refer to Page 578 for the Conversion between American Wire Gauge AWG and Wire Cross-section mm².
- Please refer to Page 22 for products' part number encoding rule.

M8 Female Molded Cable, Angled

- Connector series: M8
- Gender: Female
- Coding: A,B
- Locking type: Fix screw
- Mounting type: Right angled
- Part No.: MA08F*HD**RAXXXXXX

* refers to coding type
 ** refers to pins number
 X refers to cable specification

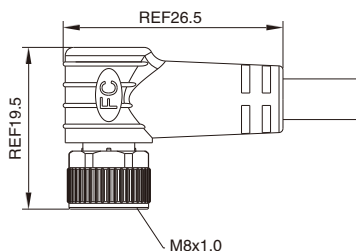

General information

Standard:	IEC 61076-2-104
Ambient temperature:	-40°C ~ +80°C(fixed installation) -20°C ~ +80°C(flexible installation)
Connector insert:	TPU; PA
Connector contacts:	Brass with gold plated
Connector overmold:	TPU
Connector nut/screw:	Zinc alloy with nickel plated
Seal / O-ring:	FKM

Insulation resistance:	≥ 100MΩ
Contact resistance:	≤ 5mΩ
Shielding:	Unavailable
IP rating:	IP67 in locked condition
Mating endurance:	>500 cycles

Electrical data & Mechanical data

Contacts	Rated current	Voltage		Wire gauge / size		Cable jacket	Part No.
		A/C	D/C	AWG	mm ²		
03 pins (A-coding)	3A	50V	60V	24AWG	0.25	PVC	MA08FAHD03RAXXCB25
						PUR	MA08FAHD03RAXXRB25
04 pins (A-coding)	3A	50V	60V	24AWG	0.25	PVC	MA08FAHD04RAXXCB25
						PUR	MA08FAHD04RAXXRB25
05 pins (B-coding)	3A	30V	30V	24AWG	0.25	PVC	MA08FBHD05RAXXCB25
						PUR	MA08FBHD05RAXXRB25
06 pins (A-coding)	1.5A	30V	30V	26AWG	0.14	PVC	MA08FAHD06RAXXCB14
						PUR	MA08FAHD06RAXXRB14
08 pins (A-coding)	1.5A	30V	30V	26AWG	0.14	PVC	MA08FAHD08RAXXCB14
						PUR	MA08FAHD08RAXXRB14

*06 Pin,08 Pin with different overmold from above other pins

Note: X refers to cable length

Remarks

- Please refer to Page 578 for the Conversion between American Wire Gauge AWG and Wire Cross-section mm².
- Please refer to Page 22 for products' part number encoding rule.

M8 Female Molded Cable, Angled, Plastic Nut

- Connector series: M8
- Gender: Female
- Coding: A,B
- Locking type: Plastic fix screw
- Mounting type: Right angled
- Part No.: MA08F*P**RAXXXXXX

* refers to coding type
 ** refers to pins number
 X refers to cable specification

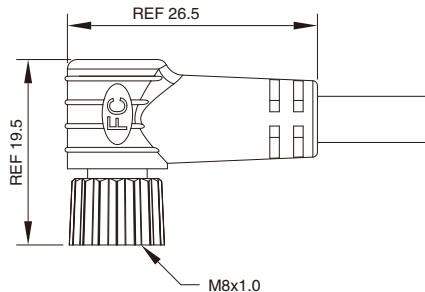

General information

Standard:	IEC 61076-2-104
Ambient temperature:	-40°C ~ +80°C(fixed installation) -20°C ~ +80°C(flexible installation)
Connector insert:	TPU; PA
Connector contacts:	Brass with gold plated
Connector overmold:	TPU
Connector nut/screw:	PA+GF
Seal / O-ring:	FKM

Insulation resistance:	≥ 100MΩ
Contact resistance:	≤ 5mΩ
Shielding:	Unavailable
IP rating:	IP67 in locked condition
Mating endurance:	>500 cycles

Electrical data & Mechanical data

Contacts	Rated current	Voltage		Wire gauge / size		Cable jacket	Part No.
		A/C	D/C	AWG	mm ²		
03 pins (A-coding)	3A	50V	60V	24AWG	0.25	PVC	MA08FAP03RAXXCB25
						PUR	MA08FAP03RAXXRB25
04 pins (A-coding)	3A	50V	60V	24AWG	0.25	PVC	MA08FAP04RAXXCB25
						PUR	MA08FAP04RAXXRB25
05 pins (B-coding)	3A	30V	30V	24AWG	0.25	PVC	MA08FBP05RAXXCB25
						PUR	MA08FBP05RAXXRB25
06 pins (A-coding)	1.5A	30V	30V	26AWG	0.14	PVC	MA08FAP06RAXXCB14
						PUR	MA08FAP06RAXXRB14
08 pins (A-coding)	1.5A	30V	30V	26AWG	0.14	PVC	MA08FAP08RAXXCB14
						PUR	MA08FAP08RAXXRB14

*06 Pin,08 Pin with different overmold from above other pins

Note: X refers to cable length

Remarks

- Please refer to Page 578 for the Conversion between American Wire Gauge AWG and Wire Cross-section mm².
- Please refer to Page 22 for products' part number encoding rule.

M8 Male Molded Cable, Angled, Shielded

- Connector series: M8
- Gender: Male
- Coding: A,B
- Locking type: Fix screw
- Mounting type: Right angled
- Part No.: MA08MS*F**RAXXXXXX

* refers to coding type
 ** refers to pins number
 X refers to cable specification

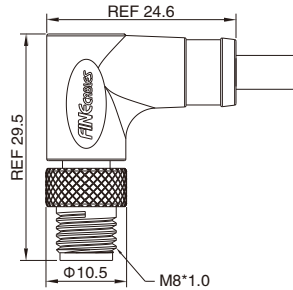

General information

Standard:	IEC 61076-2-104
Ambient temperature:	-40°C ~ +80°C (fixed installation) -20°C ~ +80°C (flexible installation)
Connector insert:	TPU
Connector contacts:	Brass with gold plated
Connector overmold:	TPU
Connector nut/screw:	Brass with nickel plated

Insulation resistance:	≥ 100MΩ
Contact resistance:	≤ 5mΩ
Shielding:	Available(not 360° shielded)
IP rating:	IP67 in locked condition
Mating endurance:	>500 cycles

Electrical data & Mechanical data

Contacts	Rated current	Voltage		Wire gauge / size		Cable jacket	Part No.
		A/C	D/C	AWG	mm ²		
03 pins (A-coding)	3A	50V	60V	24AWG	0.25	PVC	MA08MSAF03RAXXCB25
						PUR	MA08MSAF03RAXXRB25
04 pins (A-coding)	3A	50V	60V	24AWG	0.25	PVC	MA08MSAF04RAXXCB25
						PUR	MA08MSAF04RAXXRB25
05 pins (B-coding)	3A	30V	30V	24AWG	0.25	PVC	MA08MSBF05RAXXCB25
						PUR	MA08MSBF05RAXXRB25
06 pins (A-coding)	1.5A	30V	30V	26AWG	0.14	PVC	MA08MSAF06RAXXCB14
						PUR	MA08MSAF06RAXXRB14
08 pins (A-coding)	1.5A	30V	30V	26AWG	0.14	PVC	MA08MSAF08RAXXCB14
						PUR	MA08MSAF08RAXXRB14

Note: X refers to cable length

Remarks

- Please refer to Page 578 for the Conversion between American Wire Gauge AWG and Wire Cross-section mm².
- Please refer to Page 22 for products' part number encoding rule.

M8 Female Molded Cable, Angled, Shielded

- Connector series: M8
- Gender: Female
- Coding: A,B
- Locking type: Fix screw
- Mounting type: Right angled
- Part No.: MA08FS*F**RAXXXXXX

* refers to coding type
 ** refers to pins number
 X refers to cable specification

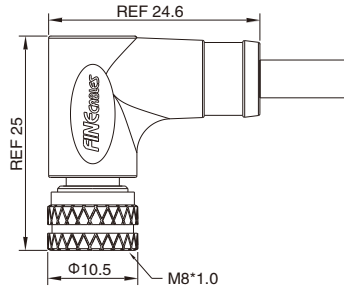

General information

Standard:	IEC 61076-2-104
Ambient temperature:	-40°C ~ +80°C(fixed installation) -20°C ~ +80°C(flexible installation)
Connector insert:	TPU; PA
Connector contacts:	Brass with gold plated
Connector overmold:	TPU
Connector nut/screw:	Brass with nickel plated
Seal / O-ring:	FKM

Insulation resistance:	≥ 100MΩ
Contact resistance:	≤ 5mΩ
Shielding:	Available(not 360° shielded)
IP rating:	IP67 in locked condition
Mating endurance:	>500 cycles

Electrical data & Mechanical data

Contacts	Rated current	Voltage		Wire gauge / size		Cable jacket	Part No.
		A/C	D/C	AWG	mm ²		
03 pins (A-coding)	3A	50V	60V	24AWG	0.25	PVC	MA08FSAF03RAXXCB25
						PUR	MA08FSAF03RAXXRB25
04 pins (A-coding)	3A	50V	60V	24AWG	0.25	PVC	MA08FSAF04RAXXCB25
						PUR	MA08FSAF04RAXXRB25
05 pins (B-coding)	3A	30V	30V	24AWG	0.25	PVC	MA08FSBF05RAXXCB25
						PUR	MA08FSBF05RAXXRB25
06 pins (A-coding)	1.5A	30V	30V	26AWG	0.14	PVC	MA08FSAF06RAXXCB14
						PUR	MA08FSAF06RAXXRB14
08 pins (A-coding)	1.5A	30V	30V	26AWG	0.14	PVC	MA08FSAF08RAXXCB14
						PUR	MA08FSAF08RAXXRB14

Note: X refers to cable length

Remarks

- Please refer to Page 578 for the Conversion between American Wire Gauge AWG and Wire Cross-section mm².
- Please refer to Page 22 for products' part number encoding rule.

M8 Male Molded Cable, Angled, Snap-in Type

- Connector series: M8
- Gender: Male
- Coding: A
- Locking type: Snap-in
- Mounting type: Right angled
- Part No.: MA08MAI**RAXXXXXX

** refers to pins number
X refers to cable specification

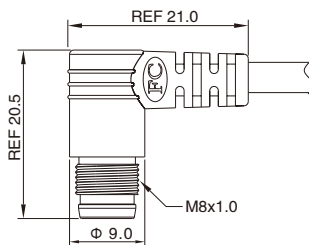

General information

Standard:	IEC 61076-2-104
Ambient temperature:	-40°C ~ +80°C(fixed installation) -20°C ~ +80°C(flexible installation)
Connector insert:	PA + GF
Connector contacts:	Brass with gold plated
Connector overmold:	TPU

Insulation resistance:	≥ 100MΩ
Contact resistance:	≤ 5mΩ
Shielding:	Unavailable
IP rating:	IP65 in locked condition
Mating endurance:	>500 cycles

Electrical data & Mechanical data

Contacts	Rated current	Voltage		Wire gauge / size		Cable jacket	Part No.
		A/C	D/C	AWG	mm ²		
03 pins (A-coding)	3A	50V	60V	24AWG	0.25	PVC	MA08MAI03RAXXCB25
						PUR	MA08MAI03RAXXRB25
04 pins (A-coding)	3A	50V	60V	24AWG	0.25	PVC	MA08MAI04RAXXCB25
						PUR	MA08MAI04RAXXRB25

Note: X refers to cable length

Remarks

- Please refer to Page 578 for the Conversion between American Wire Gauge AWG and Wire Cross-section mm².
- Please refer to Page 22 for products' part number encoding rule.

M8 Female Molded Cable, Angled, Snap-in Type

- Connector series: M8
- Gender: Female
- Coding: A
- Locking type: Snap-in
- Mounting type: Right angled
- Part No.: MA08FAI**RAXXXXXX

** refers to pins number
X refers to cable specification

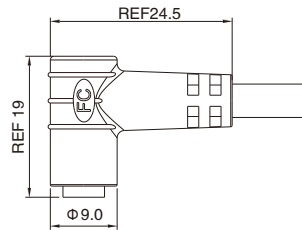



General information

Standard:	IEC 61076-2-104
Ambient temperature:	-40°C ~ +80°C(fixed installation) -20°C ~ +80°C(flexible installation)
Connector insert:	TPU; PA
Connector contacts:	Brass with gold plated
Connector overmold:	TPU

Insulation resistance:	≥ 100MΩ
Contact resistance:	≤ 5mΩ
Shielding:	Unavailable
IP rating:	IP65 in locked condition
Mating endurance:	>500 cycles

Electrical data & Mechanical data

Contacts	Rated current	Voltage		Wire gauge / size		Cable jacket	Part No.
		A/C	D/C	AWG	mm ²		
03 pins  (A-coding)	3A	50V	60V	24AWG	0.25	PVC	MA08FAI03RAXXCB25
						PUR	MA08FAI03RAXXRB25
04 pins  (A-coding)	3A	50V	60V	24AWG	0.25	PVC	MA08FAI04RAXXCB25
						PUR	MA08FAI04RAXXRB25

Note: X refers to cable length

Remarks

- Please refer to Page 578 for the Conversion between American Wire Gauge AWG and Wire Cross-section mm².
- Please refer to Page 22 for products' part number encoding rule.

M8 Female Molded Cable, Angled, with LED Indicator

- Connector series: M8
- Gender: Female
- Coding: A
- Locking type: Fix screw
- Mounting type: Right angled
- Part No.: MA08LPAF**RAXXXXXX(PNP)
MA08LNAF**RAXXXXXX(NPN)

** refers to pins number
X refers to cable specification

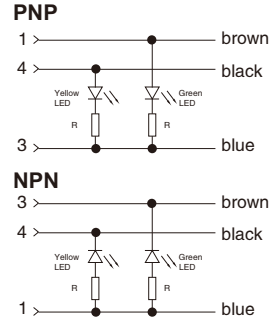
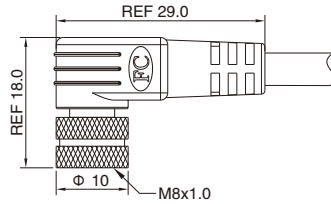

General information

Standard:	IEC 61076-2-104
Ambient temperature:	-40°C ~ +80°C(fixed installation) -20°C ~ +80°C(flexible installation)
Connector insert:	TPU; PA
Connector contacts:	Brass with gold plated
Connector overmold:	Transparent TPU
Connector nut/screw:	Brass with nickel plated
Seal / O-ring:	FKM

Insulation resistance:	≥ 100MΩ
Contact resistance:	≤ 5mΩ
Shielding:	Unavailable
IP rating:	IP67 in locked condition
Mating endurance:	>500 cycles

Electrical data & Mechanical data

Contacts	Rated current	Voltage		Wire gauge / size		Cable jacket	Part No.
		A/C	D/C	AWG	mm ²		
03 pins (A-coding)	3A	50V	60V	24AWG	0.25	PVC	MA08LPAF03RAXXCB25(PNP) MA08LPAF03RAXXRB25(PNP)
						PUR	MA08LNAF03RAXXCB25(NPN) MA08LNAF03RAXXRB25(NPN)
04 pins (A-coding)	3A	50V	60V	24AWG	0.25	PVC	MA08LPAF04RAXXCB25(PNP) MA08LPAF04RAXXRB25(PNP)
						PUR	MA08LNAF04RAXXCB25(NPN) MA08LNAF04RAXXRB25(NPN)

Note: X refers to cable length

Remarks

- Please refer to Page 578 for the Conversion between American Wire Gauge AWG and Wire Cross-section mm².
- Please refer to Page 22 for products' part number encoding rule.

M8 Male Field Wirable Assembly, Straight, Solder

- Connector series: M8
- Gender: Male
- Coding: A,B
- Locking type: Fix screw
- Mounting type: Straight
- Part No.: MB08MA*FF**ST

* refers to coding type
** refers to pins number

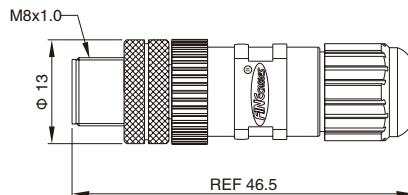

General information

Standard:	IEC 61076-2-104
Ambient temperature:	-25 °C ~ +90 °C
Connector insert/body:	TPU; PA
Connector contacts:	Brass with gold plated
Connector nut/screw:	Brass with nickel plated
Seal / O-ring:	FKM

Insulation resistance:	≥ 100MΩ
Contact resistance:	≤ 5mΩ
Shielding:	Unavailable
Suitable cable Dia:	3.5~5.0mm
IP rating:	IP67 in locked condition
Mating endurance:	>500 cycles

Electrical data & Mechanical data

Contacts	Contacts termination	Rated current	Voltage		Wire gauge / size		Cable jacket	Part No.
			A/C	D/C	AWG	mm ²		
03 pins (A-coding)	Solder version	3A	50V	60V	24AWG	0.25	PUR / PVC	MB08MAAFF03ST
04 pins (A-coding)	Solder version	3A	50V	60V	24AWG	0.25	PUR / PVC	MB08MAAFF04ST
05 pins (B-coding)	Solder version	3A	30V	30V	24AWG	0.25	PUR / PVC	MB08MABFF05ST
06 pins (A-coding)	Solder version	1.5A	30V	30V	26AWG	0.14	PUR / PVC	MB08MAAFF06ST
08 pins (A-coding)	Solder version	1.5A	30V	30V	26AWG	0.14	PUR / PVC	MB08MAAFF08ST

Remarks

- Please refer to Page 578 for the Conversion between American Wire Gauge AWG and Wire Cross-section mm².
- Please refer to Page 22 for products' part number encoding rule.

M8 Female Field Wirable Assembly, Straight, Solder

- Connector series: M8
- Gender: Female
- Coding: A,B
- Locking type: Fix screw
- Mounting type: Straight
- Part No.: MB08FA*FF**ST

* refers to coding type
** refers to pins number

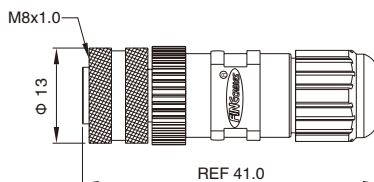

General information

Standard:	IEC 61076-2-104
Ambient temperature:	-25 °C ~ +90 °C
Connector insert/body:	TPU; PA
Connector contacts:	Brass with gold plated
Connector nut/screw:	Brass with nickel plated
Seal / O-ring:	FKM

Insulation resistance:	≥ 100MΩ
Contact resistance:	≤ 5mΩ
Shielding:	Unavailable
Suitable cable Dia:	3.5~5.0mm
IP rating:	IP67 in locked condition
Mating endurance:	>500 cycles

Electrical data & Mechanical data

Contacts	Contacts termination	Rated current	Voltage		Wire gauge / size		Cable jacket	Part No.
			A/C	D/C	AWG	mm ²		
03 pins (A-coding)	Solder version	3A	50V	60V	24AWG	0.25	PUR / PVC	MB08FAAFF03ST
04 pins (A-coding)	Solder version	3A	50V	60V	24AWG	0.25	PUR / PVC	MB08FAAFF04ST
05 pins (B-coding)	Solder version	3A	30V	30V	24AWG	0.25	PUR / PVC	MB08FABFF05ST
06 pins (A-coding)	Solder version	1.5A	30V	30V	26AWG	0.14	PUR / PVC	MB08FAAFF06ST
08 pins (A-coding)	Solder version	1.5A	30V	30V	26AWG	0.14	PUR / PVC	MB08FAAFF08ST

Remarks

- Please refer to Page 578 for the Conversion between American Wire Gauge AWG and Wire Cross-section mm².
- Please refer to Page 22 for products' part number encoding rule.

M8 Male Field Wirable Assembly, Straight, Screw joint, Shielded

- Connector series: M8
- Gender: Male
- Coding: A
- Locking type: Fix screw
- Mounting type: Straight
- Part No.: MB08MWSAFF**ST-A
MB08MWSAFF**ST-B

** refers to pins number

- suitable cable Dia: A: 3.5~4.5mm
B: 4.5~5.5mm

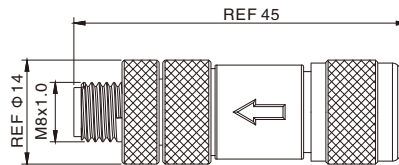

General information

Standard:	IEC 61076-2-104
Ambient temperature:	-25 °C ~ +90 °C
Connector insert/body:	PA
Connector contacts:	Brass with gold plated
Connector nut/screw:	Brass with nickel plated
Connector body:	Zinc alloy with nickel plated
Seal / O-ring:	FKM

Insulation resistance:	≥ 100MΩ
Contact resistance:	≤ 5mΩ
Shielding:	Available
Suitable cable Dia:	A: 3.5~4.5mm, B: 4.5~5.5mm
IP rating:	IP67 in locked condition
Mating endurance:	>500 cycles

Electrical data & Mechanical data

Contacts	Contacts termination	Rated current	Voltage		Wire gauge / size		Part No.
			A/C	D/C	AWG	mm ²	
03 pins (A-coding)	Screw joint	3A	50V	60V	24AWG	0.25	MB08MWSAFF03ST-A MB08MWSAFF03ST-B
04 pins (A-coding)	Screw joint	3A	50V	60V	24AWG	0.25	MB08MWSAFF04ST-A MB08MWSAFF04ST-B

Remarks

- Please refer to Page 578 for the Conversion between American Wire Gauge AWG and Wire Cross-section mm².
- Please refer to Page 22 for products' part number encoding rule.

M8 Female Field Wirable Assembly, Straight, Screw joint, Shielded

- Connector series: M8
- Gender: Female
- Coding: A
- Locking type: Fix screw
- Mounting type: Straight
- Part No.: MB08FWSAFF**ST-A
MB08FWSAFF**ST-B

** refers to pins number
 - suitable cable Dia: A: 3.5~4.5mm
 B: 4.5~5.5mm

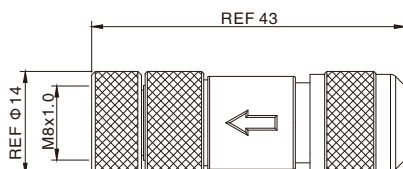

General information

Standard:	IEC 61076-2-104
Ambient temperature:	-25 °C ~ +90 °C
Connector insert/body:	PA
Connector contacts:	Brass with gold plated
Connector nut/screw:	Brass with nickel plated
Connector body:	Zinc alloy with nickel plated
Seal / O-ring:	FKM

Insulation resistance:	≥ 100MΩ
Contact resistance:	≤ 5mΩ
Shielding:	Available
Suitable cable Dia:	A: 3.5~4.5mm, B: 4.5~5.5mm
IP rating:	IP67 in locked condition
Mating endurance:	>500 cycles

Electrical data & Mechanical data

Contacts	Contacts termination	Rated current	Voltage		Wire gauge / size		Part No.
			A/C	D/C	AWG	mm ²	
03 pins (A-coding)	Screw joint	3A	50V	60V	24AWG	0.25	MB08FWSAFF03ST-A MB08FWSAFF03ST-B
04 pins (A-coding)	Screw joint	3A	50V	60V	24AWG	0.25	MB08FWSAFF04ST-A MB08FWSAFF04ST-B

Remarks

- Please refer to Page 578 for the Conversion between American Wire Gauge AWG and Wire Cross-section mm².
- Please refer to Page 22 for products' part number encoding rule.

M8 Male Panel Mount, Solder, Front fastened

- Connector series: M8
- Gender: Male
- Coding: A,B
- Locking type: Fix screw
- Mounting type: Front fastened
- Part No.: MB08MS*FF**ST

* refers to coding type
** refers to pins number

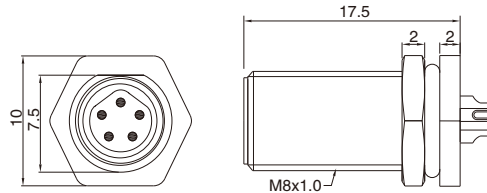

General information

Standard:	IEC 61076-2-104
Ambient temperature:	-25 °C ~ +90 °C
Connector insert:	TPU
Connector contacts:	Brass with gold plated
Connector nut/screw:	Brass with nickel plated
Seal / O-ring:	Epoxy resin / FKM

Insulation resistance:	≥ 100MΩ
Contact resistance:	≤ 5mΩ
Shielding:	Unavailable
IP rating:	IP67 in locked condition
Panel cut-out:	Refer to page 62
Mating endurance:	>500 cycles

Electrical data & Mechanical data

Contacts	Contacts termination	Rated current	Voltage		Wire gauge / size		Wire insulation	Part No.
			A/C	D/C	AWG	mm ²		
03 pins (A-coding)	Solder version	3A	50V	60V	24AWG	0.25	PVC wire or customized	MB08MSAFF03ST
04 pins (A-coding)	Solder version	3A	50V	60V	24AWG	0.25	PVC wire or customized	MB08MSAFF04ST
05 pins (B-coding)	Solder version	3A	30V	30V	24AWG	0.25	PVC wire or customized	MB08MSBFF05ST
06 pins (A-coding)	Solder version	1.5A	30V	30V	26AWG	0.14	PVC wire or customized	MB08MSAFF06ST
08 pins (A-coding)	Solder version	1.5A	30V	30V	26AWG	0.14	PVC wire or customized	MB08MSAFF08ST

Remarks

- Please refer to Page 578 for the Conversion between American Wire Gauge AWG and Wire Cross-section mm².
- Please refer to Page 22 for products' part number encoding rule.

M8 Female Panel Mount, Solder, Front fastened

- Connector series: M8
- Gender: Female
- Coding: A,B
- Locking type: Fix screw
- Mounting type: Front fastened
- Part No.: MB08FS*FF**ST

* refers to coding type
 ** refers to pins number

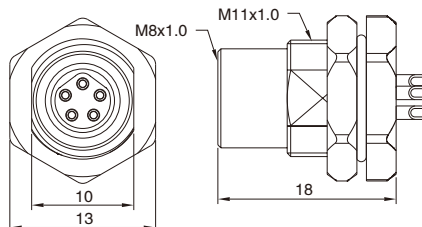

General information

Standard:	IEC 61076-2-104
Ambient temperature:	-25 °C ~ +90 °C
Connector insert:	TPU
Connector contacts:	Brass with gold plated
Connector nut/screw:	Brass with nickel plated
Seal / O-ring:	Epoxy resin / FKM

Insulation resistance:	≥ 100MΩ
Contact resistance:	≤ 5mΩ
Shielding:	Unavailable
IP rating:	IP67 in locked condition
Panel cut-out:	Refer to page 62
Mating endurance:	>500 cycles

Electrical data & Mechanical data

Contacts	Contacts termination	Rated current	Voltage		Wire gauge / size		Wire insulation	Part No.
			A/C	D/C	AWG	mm ²		
03 pins (A-coding)	Solder version	3A	50V	60V	24AWG	0.25	PVC wire or customized	MB08FSAFF03ST
04 pins (A-coding)	Solder version	3A	50V	60V	24AWG	0.25	PVC wire or customized	MB08FSAFF04ST
05 pins (B-coding)	Solder version	3A	30V	30V	24AWG	0.25	PVC wire or customized	MB08FSBFF05ST
06 pins (A-coding)	Solder version	1.5A	30V	30V	26AWG	0.14	PVC wire or customized	MB08FSAFF06ST
08 pins (A-coding)	Solder version	1.5A	30V	30V	26AWG	0.14	PVC wire or customized	MB08FSAFF08ST

Remarks

- Please refer to Page 578 for the Conversion between American Wire Gauge AWG and Wire Cross-section mm².
- Please refer to Page 22 for products' part number encoding rule.

M8 Male Panel Mount, Solder, Rear fastened

- Connector series: M8
- Gender: Male
- Coding: A,B
- Locking type: Fix screw
- Mounting type: Rear fastened
- Part No.: MB08MS*RF**ST

* refers to coding type
** refers to pins number

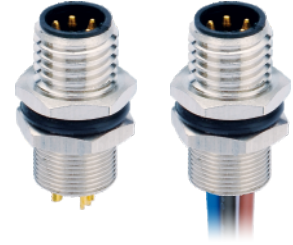
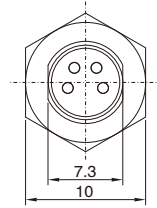
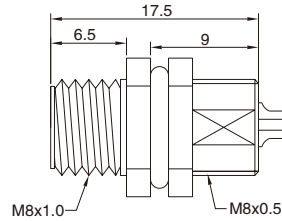

General information

Standard:	IEC 61076-2-104
Ambient temperature:	-25 °C ~ +90 °C
Connector insert:	TPU
Connector contacts:	Brass with gold plated
Connector nut/screw:	Brass with nickel plated
Seal / O-ring:	Epoxy resin / FKM

Insulation resistance:	≥ 100MΩ
Contact resistance:	≤ 5mΩ
Shielding:	Unavailable
IP rating:	IP67 in locked condition
Panel cut-out:	Refer to page 62
Mating endurance:	>500 cycles

Electrical data & Mechanical data

Contacts	Contacts termination	Rated current	Voltage		Wire gauge / size		Wire insulation	Part No.
			A/C	D/C	AWG	mm ²		
03 pins (A-coding)	Solder version	3A	50V	60V	24AWG	0.25	PVC wire or customized	MB08MSARF03ST
04 pins (A-coding)	Solder version	3A	50V	60V	24AWG	0.25	PVC wire or customized	MB08MSARF04ST
05 pins (B-coding)	Solder version	3A	30V	30V	24AWG	0.25	PVC wire or customized	MB08MSBRF05ST
06 pins (A-coding)	Solder version	1.5A	30V	30V	26AWG	0.14	PVC wire or customized	MB08MSARF06ST
08 pins (A-coding)	Solder version	1.5A	30V	30V	26AWG	0.14	PVC wire or customized	MB08MSARF08ST

Remarks

- Please refer to Page 578 for the Conversion between American Wire Gauge AWG and Wire Cross-section mm².
- Please refer to Page 22 for products' part number encoding rule.

M8 Female Panel Mount, Solder, Rear fastened

- Connector series: M8
- Gender: Female
- Coding: A,B
- Locking type: Fix screw
- Mounting type: Rear fastened
- Part No.: MB08FS*RF**ST

* refers to coding type
** refers to pins number

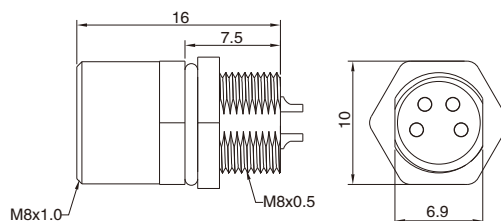

General information

Standard:	IEC 61076-2-104
Ambient temperature:	-25 °C ~ +90 °C
Connector insert:	TPU
Connector contacts:	Brass with gold plated
Connector nut/screw:	Brass with nickel plated
Seal / O-ring:	Epoxy resin / FKM

Insulation resistance:	≥ 100MΩ
Contact resistance:	≤ 5mΩ
Shielding:	Unavailable
IP rating:	IP67 in locked condition
Panel cut-out:	Refer to page 62
Mating endurance:	>500 cycles

Electrical data & Mechanical data

Contacts	Contacts termination	Rated current	Voltage		Wire gauge / size		Wire insulation	Part No.
			A/C	D/C	AWG	mm ²		
03 pins (A-coding)	Solder version	3A	50V	60V	24AWG	0.25	PVC wire or customized	MB08FSARF03ST
04 pins (A-coding)	Solder version	3A	50V	60V	24AWG	0.25	PVC wire or customized	MB08FSARF04ST
05 pins (B-coding)	Solder version	3A	30V	30V	24AWG	0.25	PVC wire or customized	MB08FSBRF05ST
06 pins (A-coding)	Solder version	1.5A	30V	30V	26AWG	0.14	PVC wire or customized	MB08FSARF06ST
08 pins (A-coding)	Solder version	1.5A	30V	30V	26AWG	0.14	PVC wire or customized	MB08FSARF08ST

Remarks

- Please refer to Page 578 for the Conversion between American Wire Gauge AWG and Wire Cross-section mm².
- Please refer to Page 22 for products' part number encoding rule.

M8 Male Panel Mount, Solder, Front fastened

- Connector series: M8
- Gender: Male
- Coding: A
- Locking type: Snap-in
- Mounting type: Front fastened
- Part No.: MB08MSAFI**ST

** refers to pins number

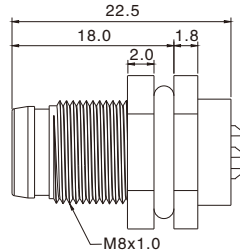



General information

Standard:	IEC 61076-2-104
Ambient temperature:	-25 °C ~ +90 °C
Connector insert:	TPU
Connector contacts:	Brass with gold plated
Connector nut/screw:	Brass with nickel plated
Seal / O-ring:	Epoxy resin / FKM

Insulation resistance:	≥ 100MΩ
Contact resistance:	≤ 5mΩ
Shielding:	Unavailable
IP rating:	IP67 in locked condition
Panel cut-out:	Refer to page 62
Mating endurance:	>500 cycles

Electrical data & Mechanical data

Contacts	Contacts termination	Rated current	Voltage		Wire gauge / size		Wire insulation	Part No.
			A/C	D/C	AWG	mm ²		
03 pins  (A-coding)	Solder version	3A	50V	60V	24AWG	0.25	PVC wire or customized	MB08MSAFI03ST
04 pins  (A-coding)	Solder version	3A	50V	60V	24AWG	0.25	PVC wire or customized	MB08MSAFI04ST

Remarks

- Please refer to Page 578 for the Conversion between American Wire Gauge AWG and Wire Cross-section mm².
- Please refer to Page 22 for products' part number encoding rule.

M8 Male Panel Mount, Solder, Rear fastened

- Connector series: M8
- Gender: Male
- Coding: A
- Locking type: Snap-in
- Mounting type: Rear fastened
- Part No.: MB08MSARI**ST

** refers to pins number

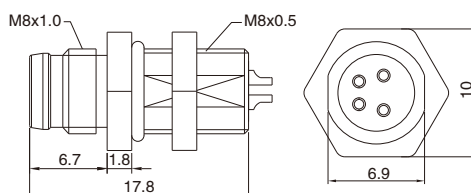

General information

Standard:	IEC 61076-2-104
Ambient temperature:	-25 °C ~ +90 °C
Connector insert:	TPU
Connector contacts:	Brass with gold plated
Connector nut/screw:	Brass with nickel plated
Seal / O-ring:	Epoxy resin / FKM

Insulation resistance:	≥ 100MΩ
Contact resistance:	≤ 5mΩ
Shielding:	Unavailable
IP rating:	IP67 in locked condition
Panel cut-out:	Refer to page 62
Mating endurance:	>500 cycles

Electrical data & Mechanical data

Contacts	Contacts termination	Rated current	Voltage		Wire gauge / size		Wire insulation	Part No.
			A/C	D/C	AWG	mm ²		
03 pins (A-coding)	Solder version	3A	50V	60V	24AWG	0.25	PVC wire or customized	MB08MSARI03ST
04 pins (A-coding)	Solder version	3A	50V	60V	24AWG	0.25	PVC wire or customized	MB08MSARI04ST

Remarks

- Please refer to Page 578 for the Conversion between American Wire Gauge AWG and Wire Cross-section mm².
- Please refer to Page 22 for products' part number encoding rule.

M8 Male Panel Mount, Solder, with LED indicator

- Connector series: M8
- Gender: Male
- Coding: A
- Locking type: Snap-in
- Mounting type: Front fastened
- Part No.: MB08MDAFI04ST

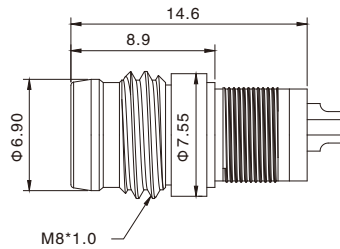

General information

Standard:	IEC 61076-2-104
Ambient temperature:	-40 °C ~ + 80 °C
Connector insert:	PC
Connector contacts:	Brass with gold plated
Connector nut/screw:	Brass with nickel plated

Insulation resistance:	≥ 100MΩ
Contact resistance:	≤ 5mΩ
Shielding:	Unavailable
IP rating:	IP67 in locked condition/ IP65 snap-in
Panel cut-out:	Refer to page 62
Mating endurance:	>500 cycles

Electrical data & Mechanical data

Contacts	Contacts termination	Rated current	Voltage		Wire gauge / size		Wire insulation	Part No.	
			A/C	D/C	AWG	mm ²			
04 pins + LED(red)	 (A-coding)	Solder version	4A	10~30V	10~30V	24AWG	0.25	PVC wire or customized	MB08MDAFI04ST

Remarks

- Please refer to Page 578 for the Conversion between American Wire Gauge AWG and Wire Cross-section mm².
- Please refer to Page 22 for products' part number encoding rule.

M8 Male Panel Mount, PCB Type, Front fastened

- Connector series: M8
- Gender: Male
- Coding: A,B
- Locking type: Fix screw
- Mounting type: Front fastened
- Part No.: MB08MB*FF**ST

* refers to coding type
 ** refers to pins number

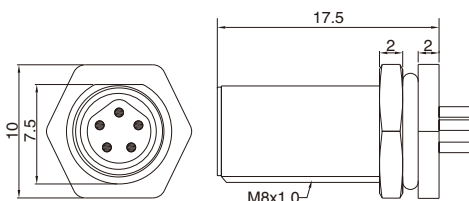

General information

Standard:	IEC 61076-2-104
Ambient temperature:	-25 °C ~ +90 °C
Connector insert:	TPU
Connector contacts:	Brass with gold plated
Connector nut/screw:	Brass with nickel plated
Seal / O-ring:	Epoxy resin / FKM

Insulation resistance:	≥ 100MΩ
Contact resistance:	≤ 5mΩ
Shielding:	Unavailable
IP rating:	IP67 in locked condition
Panel cut-out:	Refer to page 62
PCB layout:	Refer to page 61
Mating endurance:	>500 cycles

Electrical data & Mechanical data

Contacts	Contacts termination	Rated current	Voltage		Part No.
			A/C	D/C	
03 pins (A-coding)	PCB version	3A	50V	60V	MB08MBAFF03ST
04 pins (A-coding)	PCB version	3A	50V	60V	MB08MBAFF04ST
05 pins (B-coding)	PCB version	3A	30V	30V	MB08MBBFF05ST
06 pins (A-coding)	PCB version	1.5A	30V	30V	MB08MBAFF06ST
08 pins (A-coding)	PCB version	1.5A	30V	30V	MB08MBAFF08ST

Remarks

- Please refer to Page 22 for products' part number encoding rule.

M8 Female Panel Mount, PCB Type, Front fastened

- Connector series: M8
- Gender: Female
- Coding: A,B
- Locking type: Fix screw
- Mounting type: Front fastened
- Part No.: MB08FB*FF**ST

* refers to coding type
** refers to pins number

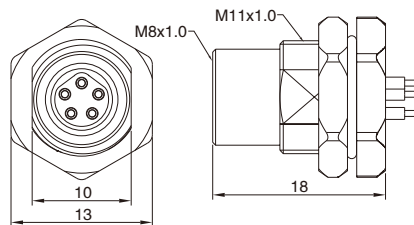

General information



Standard:	IEC 61076-2-104
Ambient temperature:	-25 °C ~ +90 °C
Connector insert:	TPU
Connector contacts:	Brass with gold plated
Connector nut/screw:	Brass with nickel plated
Seal / O-ring:	Epoxy resin / FKM

Insulation resistance:	≥ 100MΩ
Contact resistance:	≤ 5mΩ
Shielding:	Unavailable
IP rating:	IP67 in locked condition
Panel cut-out:	Refer to page 62
PCB layout:	Refer to page 61
Mating endurance:	>500 cycles

Electrical data & Mechanical data

Contacts		Contacts termination	Rated current	Voltage		Part No.
				A/C	D/C	
03 pins	(A-coding)	PCB version	3A	50V	60V	MB08FBAFF03ST
04 pins	(A-coding)	PCB version	3A	50V	60V	MB08FBAFF04ST
05 pins	(B-coding)	PCB version	3A	30V	30V	MB08FBBFF05ST
06 pins	(A-coding)	PCB version	1.5A	30V	30V	MB08FBAFF06ST
08 pins	(A-coding)	PCB version	1.5A	30V	30V	MB08FBAFF08ST

Remarks

- Please refer to Page 22 for products' part number encoding rule.

M8 Male Panel Mount, PCB Type, Front fastened

- Connector series: M8
 - Gender: Male
 - Coding: A
 - Locking type: Snap-in
 - Mounting type: Front fastened
 - Part No.: MB08MBAFI**ST
- ** refers to pins number

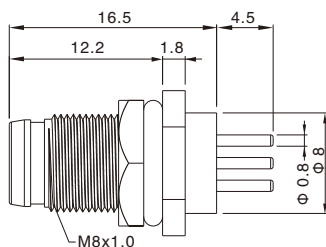

General information



Standard:	IEC 61076-2-104
Ambient temperature:	-25 °C ~ +90 °C
Connector insert:	TPU
Connector contacts:	Brass with gold plated
Connector nut/screw:	Brass with nickel plated
Seal / O-ring:	Epoxy resin / FKM

Insulation resistance:	≥ 100MΩ
Contact resistance:	≤ 5mΩ
Shielding:	Unavailable
IP rating:	IP67 in locked condition
Panel cut-out:	Refer to page 62
PCB layout:	Refer to page 61
Mating endurance:	>500 cycles

Electrical data & Mechanical data

Contacts	Contacts termination	Rated current	Voltage		Part No.
			A/C	D/C	
03 pins (A-coding)	PCB version	3A	50V	60V	MB08MBAFI03ST
04 pins (A-coding)	PCB version	3A	50V	60V	MB08MBAFI04ST

Remarks

- Please refer to Page 22 for products' part number encoding rule.

M8 Male to Female Panel Mount

- Connector series: M8
- Gender: Male/female
- Coding: A,B
- Locking type: Fix screw
- Mounting type: Straight
- Part No.: MT-004~006

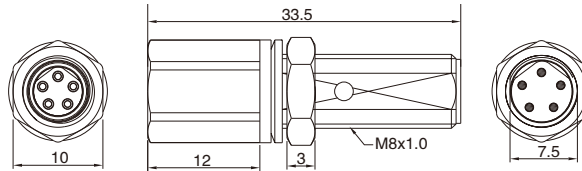

General information

Standard:	IEC 61076-2-104
Ambient temperature:	-25 °C ~ +90 °C
Connector insert:	TPU / PA+GF
Connector contacts:	Brass with gold plated
Connector nut/screw:	Brass with nickel plated
Seal / O-ring:	Epoxy resin / FKM

Insulation resistance:	≥ 100MΩ
Contact resistance:	≤ 5mΩ
Shielding:	Unavailable
IP rating:	IP67 in locked condition
Panel cut-out:	Refer to page 62
Mating endurance:	>500 cycles

Electrical data & Mechanical data

	Contacts		Rated current	Voltage		Part No.
				A/C	D/C	
03 pins (A-coding)			3A	50V	60V	MT-004
04 pins (A-coding)			3A	50V	60V	MT-005
05 pins (B-coding)			3A	30V	30V	MT-006

M8 Male Panel Mount, Angled, PCB Type, Front fastened, Shielded

- Connector series: M8
- Gender: Male
- Coding: A,B
- Locking type: Fix screw
- Mounting type: Front fastened
- Part No.: MB08MBS*FF**RA

* refers to coding type
 ** refers to pins number

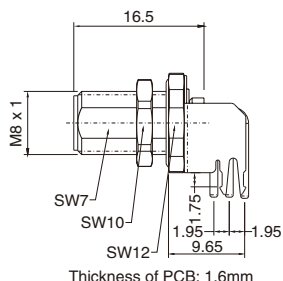

General information

Standard:	IEC 61076-2-104
Ambient temperature:	-25 °C ~ +90 °C
Connector insert:	TPU
Connector contacts:	Brass with gold plated
Connector nut/screw:	Brass with nickel plated
Seal / O-ring:	Epoxy resin / FKM

Insulation resistance:	≥ 100MΩ
Contact resistance:	≤ 5mΩ
Shielding:	Available
IP rating:	IP67 in locked condition
Panel cut-out:	Refer to page 62
PCB layout:	Refer to page 61
Mating endurance:	>500 cycles

Electrical data & Mechanical data

Contacts		Contacts termination	Rated current	Voltage		Part No.
				A/C	D/C	
03 pins	 (A-coding)	PCB version	3A	50V	60V	MB08MBSAFF03RA
04 pins	 (A-coding)	PCB version	3A	50V	60V	MB08MBSAFF04RA
05 pins	 (B-coding)	PCB version	3A	30V	30V	MB08MBSBFF05RA

Remarks

- Please refer to Page 22 for products' part number encoding rule.

M8 Female Panel Mount, Angled, PCB Type, Front fastened, Shielded

- Connector series: M8
- Gender: Female
- Coding: A,B
- Locking type: Fix screw
- Mounting type: Front fastened
- Part No.: MB08FBS*FF**RA

* refers to coding type
 ** refers to pins number

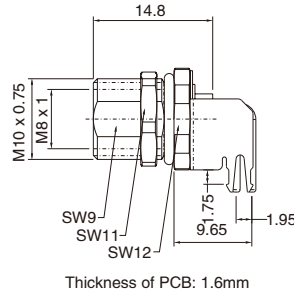

General information

Standard:	IEC 61076-2-104
Ambient temperature:	-25 °C ~ +90 °C
Connector insert:	PA+GF
Connector contacts:	Brass with gold plated
Connector nut/screw:	Brass with nickel plated
Seal / O-ring:	Epoxy resin / FKM

Insulation resistance:	≥ 100MΩ
Contact resistance:	≤ 5mΩ
Shielding:	Available
IP rating:	IP67 in locked condition
Panel cut-out:	Refer to page 62
PCB layout:	Refer to page 61
Mating endurance:	>500 cycles

Electrical data & Mechanical data

Contacts		Contacts termination	Rated current	Voltage		Part No.
				A/C	D/C	
03 pins		PCB version	3A	50V	60V	MB08FBSAFF03RA
04 pins		PCB version	3A	50V	60V	MB08FBSAFF04RA
05 pins		PCB version	3A	30V	30V	MB08FBSBFF05RA

Remarks

- Please refer to Page 22 for products' part number encoding rule.

M8 Y-Splitter, Male-2*Female

- Connector series: M8
- Gender: Female & Male
- Coding: A,B
- Locking type: Fix screw
- Mounting type: Y-Type
- Part No.: MT-043~045

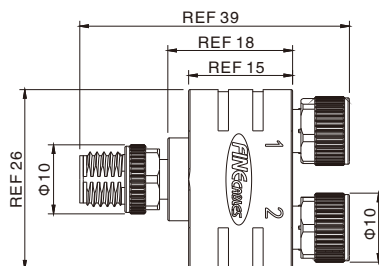

General information

Ambient temperature:	-20 °C ~ +80 °C
Connector insert:	PA+GF / TPU
Connector contacts:	Brass with gold plated
Connector screw/nut:	Zinc alloy with nickel plated
Innere mold:	PP
Overmold:	PVC
O-ring:	FKM

Insulation resistance:	≥ 100MΩ
Contact resistance:	≤ 5mΩ
Shielding:	Unavailable
IP rating:	IP67 in locked condition
Mating endurance:	>500 cycles

Electrical data & Mechanical data

Contacts	Wire List	Rated current	Voltage		Part No.
			A/C	D/C	
03 pins (A-coding) 		3A	50V	60V	MT-043
04 pins (A-coding) 		3A	50V	60V	MT-044
05 pins (B-coding) 		3A	30V	30V	MT-045

M8 L-Adapter, Male-Female

- Connector series: M8
- Gender: Female & Male
- Coding: A,B
- Locking type: Fix screw
- Mounting type: Right angled
- Part No.: MT-046~048

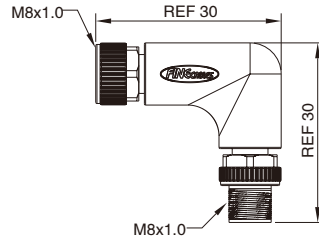

General information

Standard:	IEC 61076-2-104
Ambient temperature:	-20 °C ~ +80 °C
Connector insert:	TPU/PA
Connector contacts:	Brass with gold plated
Connector overmold:	TPU
Connector nut/screw:	Zinc alloy with nickel plated
Seal/O-ring:	FKM

Insulation resistance:	≥ 100MΩ
Contact resistance:	≤ 5mΩ
Shielding:	Unavailable
IP rating:	IP67 in locked condition
Mating endurance:	>500 cycles

Electrical data & Mechanical data

Contacts	Wire List	Rated current	Voltage		Part No.												
			A/C	D/C													
03 pins (A-coding) 	<table border="0"> <tr> <td>Male</td> <td>Female</td> </tr> <tr> <td>1 _____</td> <td>1</td> </tr> <tr> <td>2 _____</td> <td>2</td> </tr> <tr> <td>3 _____</td> <td>3</td> </tr> </table>	Male	Female	1 _____	1	2 _____	2	3 _____	3	3A	50V	60V	MT-046				
Male	Female																
1 _____	1																
2 _____	2																
3 _____	3																
04 pins (A-coding) 	<table border="0"> <tr> <td>Male</td> <td>Female</td> </tr> <tr> <td>1 _____</td> <td>1</td> </tr> <tr> <td>2 _____</td> <td>2</td> </tr> <tr> <td>3 _____</td> <td>3</td> </tr> <tr> <td>4 _____</td> <td>4</td> </tr> </table>	Male	Female	1 _____	1	2 _____	2	3 _____	3	4 _____	4	3A	50V	60V	MT-047		
Male	Female																
1 _____	1																
2 _____	2																
3 _____	3																
4 _____	4																
05 pins (B-coding) 	<table border="0"> <tr> <td>Male</td> <td>Female</td> </tr> <tr> <td>1 _____</td> <td>1</td> </tr> <tr> <td>2 _____</td> <td>2</td> </tr> <tr> <td>3 _____</td> <td>3</td> </tr> <tr> <td>4 _____</td> <td>4</td> </tr> <tr> <td>5 _____</td> <td>5</td> </tr> </table>	Male	Female	1 _____	1	2 _____	2	3 _____	3	4 _____	4	5 _____	5	3A	30V	30V	MT-048
Male	Female																
1 _____	1																
2 _____	2																
3 _____	3																
4 _____	4																
5 _____	5																

M8 Male Terminator, Straight, with LED Indicator

- Connector series: M8
- Gender: Male
- Coding: A,B
- Locking type: Fix screw
- Mounting type: Straight
- Part No.: MA08M*HD**ST-LED

* refers to coding type
 ** refers to pins number

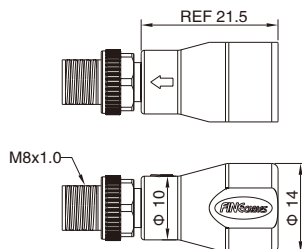

General information

Ambient temperature:	-20 °C ~ +80 °C
Connector insert:	TPU + GF
Connector contacts:	Brass with gold plated
Connector overmold:	Transparent TPU
Coupling nut/screw:	Zinc alloy with nickel plated

Insulation resistance:	≥ 100MΩ
Contact resistance:	≤ 5mΩ
Shielding:	Unavailable
IP rating:	IP67 in locked condition
Mating endurance:	>500 cycles

Electrical data & Mechanical data

Contacts	Rated current	Voltage		Part No.
		A/C	D/C	
03 pins (A-coding)	3A	50V	60V	MA08MAHD03ST-LED
04 pins (A-coding)	3A	50V	60V	MA08MAHD04ST-LED
05 pins (B-coding)	3A	30V	30V	MA08MBHD05ST-LED

Remarks

- Please refer to Page 22 for products' part number encoding rule.

M8 Protection Cap for Male Snap in Connector

- Connector series: M8
- Gender: for Male
- Locking type: Fix screw
- Part No.: PCNM8x1.0-1

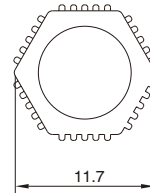
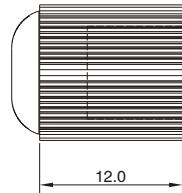

General information

Material:	PA+ GF
O-ring:	FKM
Color:	Black
Degree of protection:	IP67 in locked condition

M8 Protection Cap for Female Connector

- Connector series: M8
- Gender: for Female
- Locking type: Fix screw
- Part No.: PCSM8x1.0-1

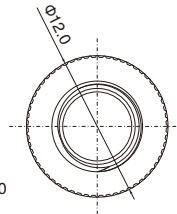
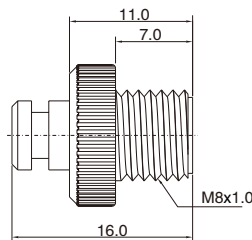

General information

Material:	PA+ GF
Color:	Black
Degree of protection:	IP67 in locked condition

M8 Protection Cap for Male Molded Cable Connector

- Connector series: M8
- Gender: for Male
- Locking type: Fix screw
- Part No.: PCNM8x1.0-2

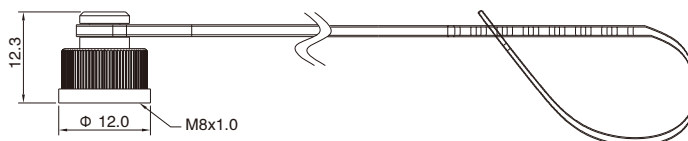

General information

Material:	PA+ GF
Gasket:	FKM
Loop:	TPU
Color:	Black
Degree of protection:	IP67 in locked condition

M8 Protection Cap for Female Molded Cable Connector

- Connector series: M8
- Gender: for Female
- Locking type: Fix screw
- Part No.: PCSM8x1.0-2

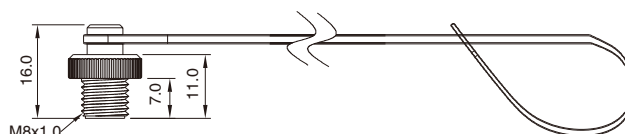

General information

Material:	PA+ GF
Loop:	TPU
Color:	Black
Degree of protection:	IP67 in locked condition

M8 Protection Cap for Male Panel-mount Connector

- Connector series: M8
- Gender: for Male
- Locking type: Fix screw
- Part No.: PCNM8x1.0-3

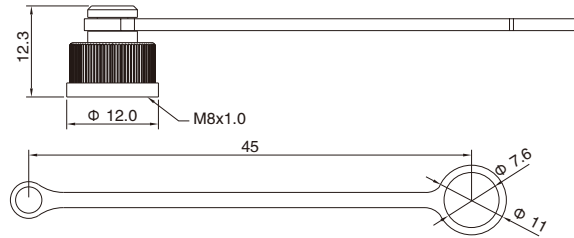

General information

Material:	PA+GF
Gasket:	FKM
Loop:	TPU
Color:	Black
Degree of protection:	IP67 in locked condition

M8 Protection Cap for Female Panel-mount Connector

- Connector series: M8
- Gender: for Female
- Locking type: Fix screw
- Part No.: PCSM8x1.0-3

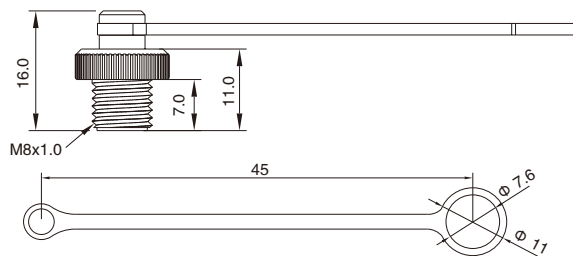

General information

Material:	PA+GF
Loop:	TPU
Color:	Black
Degree of protection:	IP67 in locked condition

M8 PCB Layout & Panel Cut-out

PCB Layout

M8 Male Connector

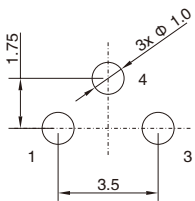

3P (Pin OD: Φ 0.8)

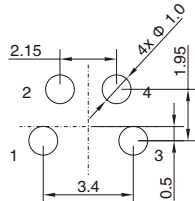

4P (Pin OD: Φ 0.8)

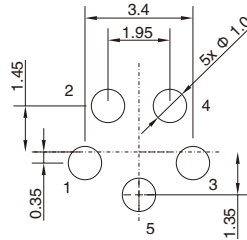

5P (Pin OD: Φ 0.8)

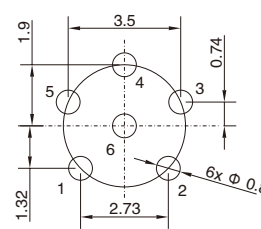

6P (Pin OD: Φ 0.6)

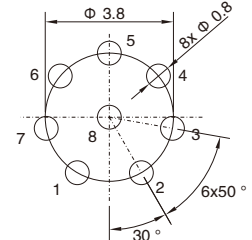

8P (Pin OD: Φ 0.6)

Recommended PCB layout

M8 Female Connector

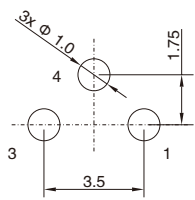

3P (Pin OD: Φ 0.8)

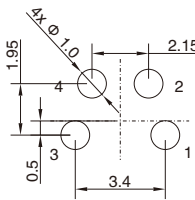

4P (Pin OD: Φ 0.8)

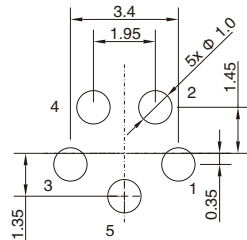

5P (Pin OD: Φ 0.8)

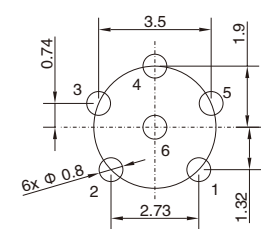

6P (Pin OD: Φ 0.6)

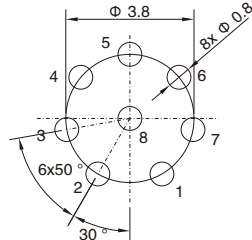

8P (Pin OD: Φ 0.6)

Recommended PCB layout

M8 Male Right Angled Connector

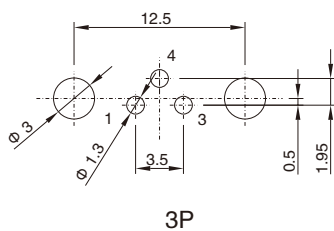

3P

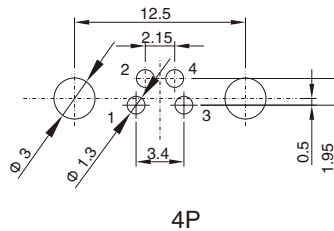

4P

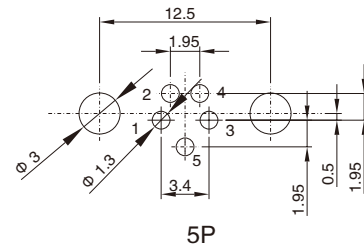

5P

Recommended PCB layout

M8 PCB Layout & Panel Cut-out

PCB Layout

M8 Female Right Angled Connector

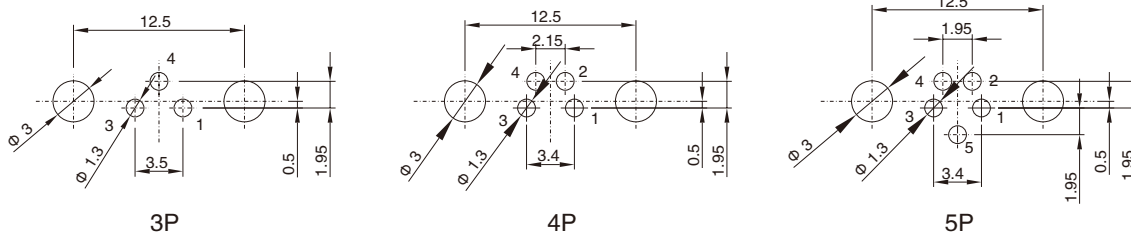

Recommended PCB layout

Panel Cut-out Dimensions

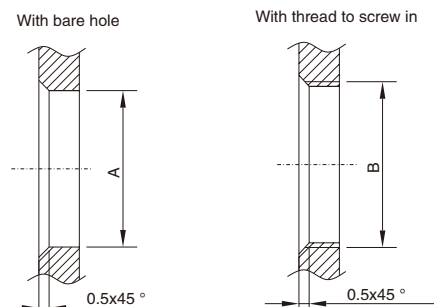

	A	B
M8	$8.0^{+0.1}_{-0}$	M8x0.5
M8	$8.0^{+0.1}_{-0}$	M8x1.0
M11	$11.0^{+0.1}_{-0}$	M11x1.0

H-cutting

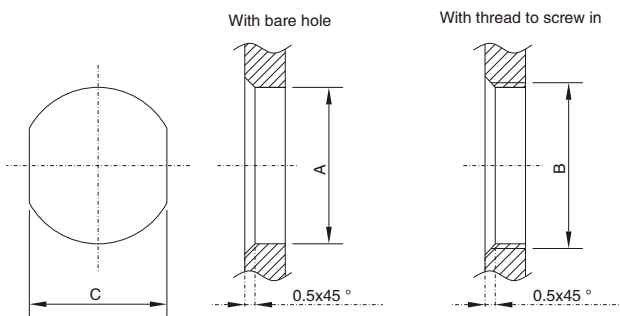

	A	B	C
M8	$8.0^{+0.1}_{-0}$	M8x0.5	$7.1^{+0.1}_{-0}$
M8	$8.0^{+0.1}_{-0}$	M8x0.5	$7.4^{+0.1}_{-0}$
M8	$8.0^{+0.1}_{-0}$	M8x1.0	$7.1^{+0.1}_{-0}$
M10	$10.0^{+0.1}_{-0}$	M10x0.75	$9.1^{+0.1}_{-0}$
M11	$11.0^{+0.1}_{-0}$	M11x1.0	$10.1^{+0.1}_{-0}$

D-cutting

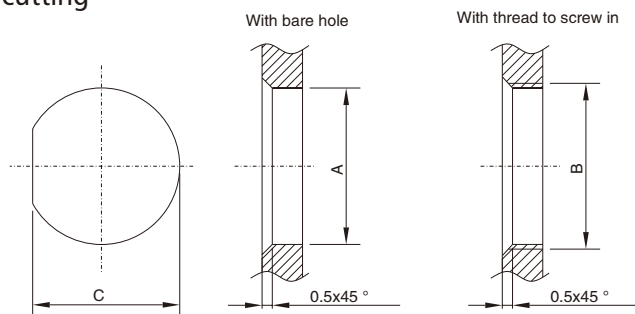

	A	B	C
M8	$8.0^{+0.1}_{-0}$	M8x1.0	$7.6^{+0.1}_{-0}$